

# Ubiflux Vigor W400

Heat recovery unit



**Tested to:**

**BS-EN  
308:1997**

**Standards**



**77W\***

\* maximum power per fan

**85%  
Efficiency\*\***

\*\* thermal efficiency at maximum flow

## → Characteristics

- Extremely energy-efficient unit with very high thermal efficiency
- Accurate constant-flow 2.0 - guarantees as much air supply as air extraction
- TFT display touchscreen with well organised menu structure, including easy to use installation and maintenance wizards
- Fully automatic summer bypass fitted as standard
- Intelligent frost protection
- Practical in maintenance and minimal service parts
- Fast upgrade to the “Plus” version
- Compact unit - smallest in its class
- Passivhaus Certified

## → Modern communication

		Basic	Plus
1x RJ12 cable	Control via 4-position switch; RF receiver connection	X	X
1x E-Bus	Connection clock module zone ventilation, Ubiflux Home (app), CO2 sensor or extra pre or post heater	X	X
1x 24v signal output	Programming an error and filter signal	X	X
1x 24v power supply	Connection for CO2 sensors (maximum 4 sensors)	X	X
1x Print connection	Moisture sensor connection	X	X
1x Modbus / Brinkbus	Simple link with building management system; plusprint connection; cascade	X	X
1x (W)LAN	Direct (wireless) connection Ubiflux Home environment (app)		X
2x analogue input 0-10v	Connection for external sensors (CO2, RH, VOC, I / O module)		X
2x contact input	Programmable input closed or open contact (9 pre-programmed action options)		X
2x relay output 0-24v	Connection for geothermal heat exchanger; relay 2 can also be activated at contact input		X
2x analogue output 0-10v	Connection for geothermal heat exchanger		X
1x 10K NTC resistance	External temperature sensor connection required for geothermal heat exchanger		X

## ➔ Specifications













<b>Ventilation capacity at 200Pa [m³/h]</b> 50-400	<b>Constant-flow</b> Vane Anemometer (very accurate)
<b>Duct connections</b> 4x ø180mm	<b>Condensate Drain</b> ø32 (ball siphon included)
<b>Max fan power [W]</b> 2 x 77	<b>SPI (Specific Power Input)</b> 0,17W/m³/h
<b>Dimensions [mm] 4/0 / Dimensions [mm] 2/2</b> 650x750x560      710x750x562	<b>Weight [kg]</b> 37
<b>Filter Class</b> G4 ISO Coarse 60%	<b>Frost protection</b> Intelligent frost regulation with pre-heater

## ➔ Item Numbers









- 100000884004 Ubiflux Vigor W400 4/0 right
- 100000884000 Ubiflux Vigor W400 4/0 left
- 100000884003 Ubiflux Vigor W400 2/2 right
- 100000884002 Ubiflux Vigor W400 2/2 left
- 100000883246 Ubiflux Vigor Plusprint
- 100000883242 Ubiflux Vigor floor mounting stand
- 100000883243 Ubiflux Vigor floor mounting stand + front cover
- 100000888049 Ubiflux Vigor Filter Set IC60% (G4) Pack of 2

## ➔ Connections

The Ubiflux Vigor is available in a left or right hand version. With the left hand version, the "warm" connections (from home and to home) are connected to the left side of the unit. The condensate drain is then mounted in the right opening under the unit. With the right hand version the "warm" connections (to the home and from the home) are connected to the right side of the unit. This position guarantees better air flow from the fan as well as a positive effect on both efficiency and energy consumption.

		Left Version		Right Version	
	Fresh air				
	Outwards				
	Drain				
	Supply				
F	Filter				

## ➔ Dimensions & Configurations

Enter	Left Version	Right Version
1		
	To the Home	To the Home
2		
	To the Outside	To the Outside
3		
	From the Home	From the Home
4		
	From the Outside	From the Outside
5	Electrical connection	Electrical connection
6	Condensate Drain (6b)	Condensate Drain (6a)
7	Extract Filter	Extract Filter
8	Supply Filter	Supply Filter
9	Wall Mounting	Wall Mounting

Left-hand version

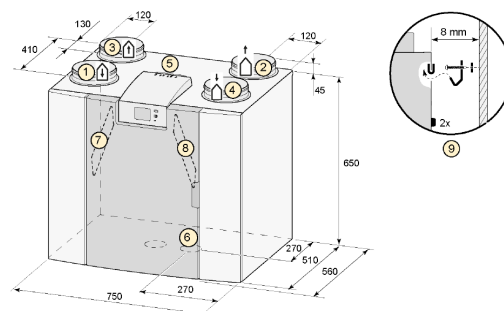

Right-hand version

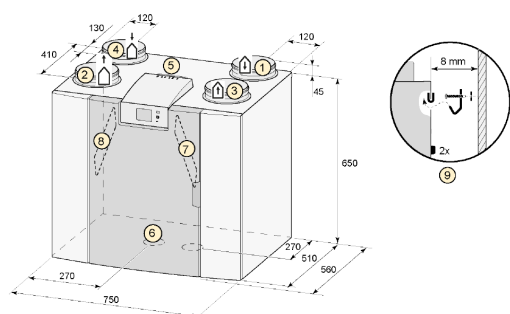

## → Components

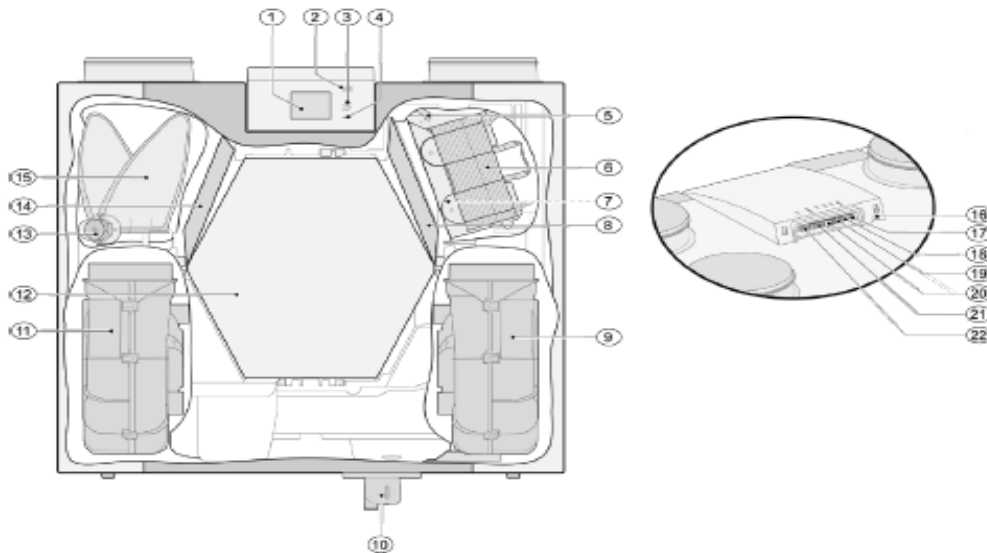

The device shown above is a left-hand version; in the right-hand version, the connection of the pre-heater, bypass valve and the siphon are mirror-mounted.

1	Touchscreen	9	Extract fan	17	Relay output (x19)
2	USB connection (x13)	10	Siphon Connection	18	24 volt connection (x18)
3	Service connection point	11	Supply fan	19	E-bus connection (x17)
4	LED indication	12	Heat exchanger	20	24 volt connection (x16)
5	Maximum protection preheater	13	Motor Bypass Valve	21	Modbus connection (x15)
6	Preheater	14	Supply filter	22	Connection position switch (x14)
7	Temperature sensor	15	Bypass Valve		
8	Extract filter	16	230 volt power cord		

## → Fan Chart

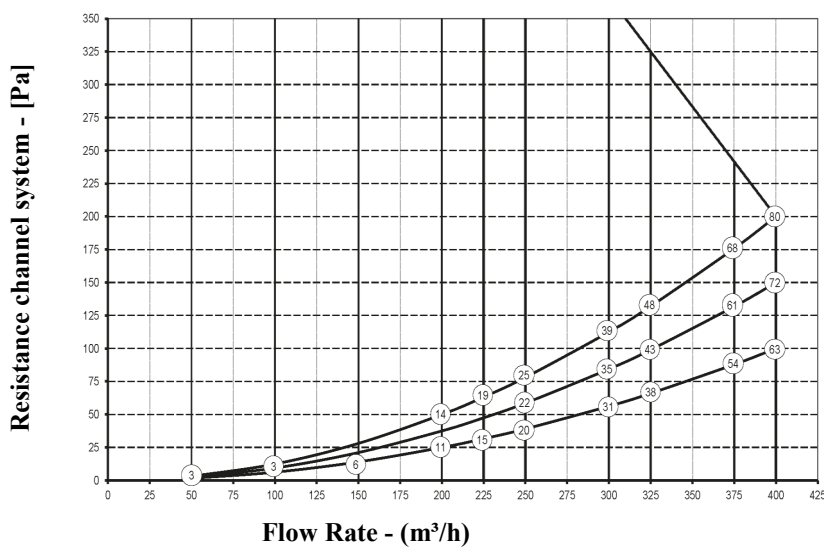

### Please note:

The value stated in the circle is the power (watts) per fan.

The device is limited to 200Pa to guarantee a minimum sound quality.

➔ **Sound power**

	Q [m³/h]	P [Pa]	f [Hz]: Filter	63 LW [dB]	125 LW [dB]	250 LW [dB]	500 LW [dB]	1000 LW [dB]	2000 LW [dB]	4000 LW [dB]	8000 LW [dB]	Total LW [dB]	Total weigh ed LWA [dB]
<b>Including final correction</b>	<b>To Home</b>												
	100	25	ISO Coarse 60%	63.2	50.8	47.5	42.9	36.4	24.8	15.7	18.2	63.5	44.5
	150	25	ISO Coarse 60%	65.8	58.8	51.3	47.8	42	33.5	21.9	20.3	66.8	50
	150	50	ISO Coarse 60%	61.9	55.1	52.8	49.7	43.9	36.5	25.1	25.5	63.4	50.5
	200	100	ISO Coarse 60%	65.1	59.7	58.7	55.6	50.5	45	35.9	23.6	67.3	57
	250	50	ISO Coarse 60%	65.6	58	61.5	56.5	51.6	47.2	38.7	25	68	58
	250	100	ISO Coarse 60%	66.5	60.2	66.2	57.4	53.1	48.6	40.3	27.5	70.2	60.5
	350	100	ISO Coarse 60%	69	65	74.7	62.5	58.1	55.6	49.2	38.1	76.5	69.5
	400	150	ISO Coarse 60%	71.7	67.6	75.5	71.7	61.2	59.1	53.4	43.2	78.6	72
	<b>From Home</b>												
	100	25	ISO Coarse 60%	53.8	48	41.5	29.2	16.9	10.6	11.2	17	55	36
	150	25	ISO Coarse 60%	61	56	48.6	39.1	24	18.8	10.7	18	62.4	43.5
	150	50	ISO Coarse 60%	59.3	55.6	48.5	38.7	25.4	21.3	11.7	17.4	61.1	43.5
	200	100	ISO Coarse 60%	59.7	57.1	51.2	39	31.1	29.3	18.1	16.6	62	45
	250	50	ISO Coarse 60%	55.4	56.6	55	38.8	31.4	30.9	19.4	16.5	60.5	46.5
	250	100	ISO Coarse 60%	55.4	57.6	55.1	40.6	33.3	32.6	21.8	16.7	61	48
	350	100	ISO Coarse 60%	61.3	60	56.4	44.4	38.1	39	29.1	18.5	64.5	51
	325	150	ISO Coarse 60%	62.9	65.3	62.6	57.8	41.3	42.5	33.1	21.1	68.9	58
	<b>To the Outside</b>												
	400	150	ISO Coarse 60%	71.8	68	74.4	67.8	61	58.6	52.5	42.7	77.6	70.5
<b>From the Outside</b>													
400	150	ISO Coarse 60%	62.7	64.3	62.2	54.3	43.7	42.7	32.9	22.5	68.1	57	

	Q [m³/h]	P [Pa]	f [Hz]: Filter	63 LW [dB]	125 LW [dB]	250 LW [dB]	500 LW [dB]	1000 LW [dB]	2000 LW [dB]	4000 LW [dB]	8000 LW [dB]	Total LW [dB]	Total weighed LWA [dB]
<b>Casing Radiation</b>	100	25	ISO Coarse 60%	32.5	33.1	35	26.7	18.9	12.9	3.1	6.5	38.8	29
	150	25	ISO Coarse 60%	38.5	42.7	41.5	36	27.1	21.2	10.9	14.4	46.5	37
	150	50	ISO Coarse 60%	43.6	41	39.7	32.8	26.6	23.5	10.8	7.4	46.8	35.5
	200	100	ISO Coarse 60%	44.5	45.2	47	38.7	32.9	31.3	27.8	14.1	50.9	41.5
	250	50	ISO Coarse 60%	42	42.4	50.9	38.8	33.1	32.8	25.5	29.3	52.3	43.5
	250	100	ISO Coarse 60%	43.4	43.9	56.6	40.6	35	34.3	24.9	20.8	57.2	49
	300	100	ISO Coarse 60%	44.6	46.4	54.4	42.6	37.4	37.7	29.7	29.8	55.8	48
	350	100	ISO Coarse 60%	46.5	48.2	57.6	45.8	39.8	41.1	33	27.3	58.7	52
	400	150	ISO Coarse 60%	47.2	52.1	62.8	54.3	43.2	44.5	37.4	31.9	63.9	57.5



**Ubiflux Vigor**  
**Pure power!**